

COPYRIGHT © Hangzhou EZVIZ Software Co., Ltd. ALL RIGHTS RESERVED.

Any and all information, including, among others, wordings, pictures, graphs are the properties of Hangzhou EZVIZ Software Co., Ltd. (hereinafter referred to as “EZVIZ”). This user manual (hereinafter referred to as “the Manual”) cannot be reproduced, changed, translated, or distributed, partially or wholly, by any means, without the prior written permission of EZVIZ. Unless otherwise stipulated, EZVIZ does not make any warranties, guarantees or representations, express or implied, regarding to the Manual.

### **About this Manual**

The Manual includes instructions for using and managing the product. Pictures, charts, images and all other information hereinafter are for description and explanation only. The information contained in the Manual is subject to change, without notice, due to firmware updates or other reasons. Please find the latest version in the ezviz™ website (<http://www.ezviz.com>).

### **Revision Record**

New release – May 2022

### **Trademarks Acknowledgement**

ezviz™, ™, and other EZVIZ’s trademarks and logos are the properties of EZVIZ in various jurisdictions. Other trademarks and logos mentioned below are the properties of their respective owners.

### **Legal Disclaimer**

TO THE MAXIMUM EXTENT PERMITTED BY APPLICABLE LAW, THE PRODUCT DESCRIBED, WITH ITS HARDWARE, SOFTWARE AND FIRMWARE, IS PROVIDED “AS IS”, WITH ALL FAULTS AND ERRORS, AND EZVIZ MAKES NO WARRANTIES, EXPRESS OR IMPLIED, INCLUDING WITHOUT LIMITATION, MERCHANTABILITY, SATISFACTORY QUALITY, FITNESS FOR A PARTICULAR PURPOSE, AND NON-INFRINGEMENT OF THIRD PARTY. IN NO EVENT WILL EZVIZ, ITS DIRECTORS, OFFICERS, EMPLOYEES, OR AGENTS BE LIABLE TO YOU FOR ANY SPECIAL, CONSEQUENTIAL, INCIDENTAL, OR INDIRECT DAMAGES, INCLUDING, AMONG OTHERS, DAMAGES FOR LOSS OF BUSINESS PROFITS, BUSINESS INTERRUPTION, OR LOSS OF DATA OR DOCUMENTATION, IN CONNECTION WITH THE USE OF THIS PRODUCT, EVEN IF EZVIZ HAS BEEN ADVISED OF THE POSSIBILITY OF SUCH DAMAGES.

TO THE MAXIMUM EXTENT PERMITTED BY APPLICABLE LAW, IN NO EVENT SHALL EZVIZ’S TOTAL LIABILITY FOR ALL DAMAGES EXCEED THE ORIGINAL PURCHASE PRICE OF THE PRODUCT.

EZVIZ DOES NOT UNDERTAKE ANY LIABILITY FOR PERSONAL INJURY OR PROPERTY DAMAGE AS THE RESULT OF PRODUCT INTERRUPTION OR SERVICE TERMINATION CAUSED BY: A) IMPROPER INSTALLATION OR USAGE OTHER THAN AS REQUESTED; B) THE PROTECTION OF NATIONAL OR PUBLIC INTERESTS; C) FORCE MAJEURE; D) YOURSELF OR THE THIRD PARTY, INCLUDING WITHOUT LIMITATION, USING ANY THIRD PARTY’S PRODUCTS, SOFTWARE, APPLICATIONS, AND AMONG OTHERS.

REGARDING TO THE PRODUCT WITH INTERNET ACCESS, THE USE OF PRODUCT SHALL BE WHOLLY AT YOUR OWN RISKS. EZVIZ SHALL NOT TAKE ANY RESPONSIBILITIES FOR ABNORMAL OPERATION, PRIVACY LEAKAGE OR OTHER DAMAGES RESULTING FROM CYBER ATTACK, HACKER ATTACK, VIRUS INSPECTION, OR OTHER INTERNET SECURITY RISKS; HOWEVER, EZVIZ WILL PROVIDE TIMELY TECHNICAL SUPPORT IF REQUIRED. SURVEILLANCE LAWS AND DATA PROTECTION LAWS VARY BY JURISDICTION. PLEASE CHECK ALL RELEVANT LAWS IN YOUR JURISDICTION BEFORE USING THIS PRODUCT IN ORDER TO ENSURE THAT YOUR USE CONFORMS TO THE APPLICABLE LAW. EZVIZ SHALL NOT BE LIABLE IN THE EVENT THAT THIS PRODUCT IS USED WITH ILLEGITIMATE PURPOSES.

IN THE EVENT OF ANY CONFLICTS BETWEEN THE ABOVE AND THE APPLICABLE LAW, THE LATTER PREVAILS.

# Table of Contents

<b>Overview</b> .....	<b>1</b>
1. Package Contents .....	1
2. Tools You May Need .....	2
3. Basics (Doorbell) .....	2
4. Basics (Chime) .....	3
<b>Setup</b> .....	<b>3</b>
1. Get the EZVIZ App .....	3
2. Choose an Installation Location .....	4
3. Plug in Chime .....	4
4. Add the Chime to EZVIZ .....	4
5. Power On the Doorbell .....	5
6. Check the Linkage .....	5
<b>Installation</b> .....	<b>6</b>
1. Micro SD Card Installation (Optional) .....	6
2. Doorbell Installation Height .....	6
3. Select the mounting plate .....	6
4. Install the mounting plate .....	8
5. Install the doorbell .....	9
<b>Maintenance</b> .....	<b>10</b>
1. Disassemble .....	10
2. Charge .....	10
<b>Appendix (Optional)</b> .....	<b>10</b>
Replace the existing doorbell with the EZVIZ doorbell .....	10
<b>View Your Device</b> .....	<b>12</b>
1. Live View .....	12
<b>Settings</b> .....	<b>13</b>
1. Doorbell .....	13
2. Chime .....	13
<b>EZVIZ Connect</b> .....	<b>14</b>
1. Use Amazon Alexa .....	14
2. Use Google Assistant .....	15
<b>Initiatives on the Use of Video Products</b> .....	<b>16</b>
<b>Appendix</b> .....	<b>17</b>
1. Rechargeable Lithium ion Battery .....	17
2. INFORMATION FOR PRIVATE HOUSEHOLDS .....	17

# Overview

## 1. Package Contents

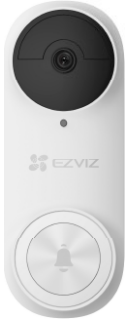

Doorbell (x1)

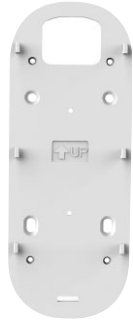

Mounting Plate (x1)



Inclined Mounting Plate (x2)  
Pick the one for best surveillance angle.

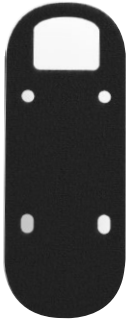

Foam Sticker (x1)

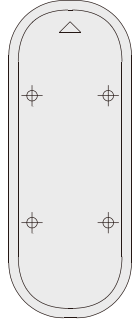

Drill Template (x1)



Plate Foam (x1)



Chime (x1)



Screwdriver (x1)



Screw Kit (x1)



Screw Kit (x1)



U-shaped Wire (x2)



Wire Connector (x3)



Pin (x1)



USB Cable (x1)



Quick Installation Guide(x1)



Regulatory Information (x3)



Quick Start Guide (x1)

**i** The appearance of chime is subject to the actual one you have bought.

## 2. Tools You May Need



Drill (x1)

- It is recommended to use a drill with diameter of 6mm.
- The tool should be purchased separately.

## 3. Basics (Doorbell)

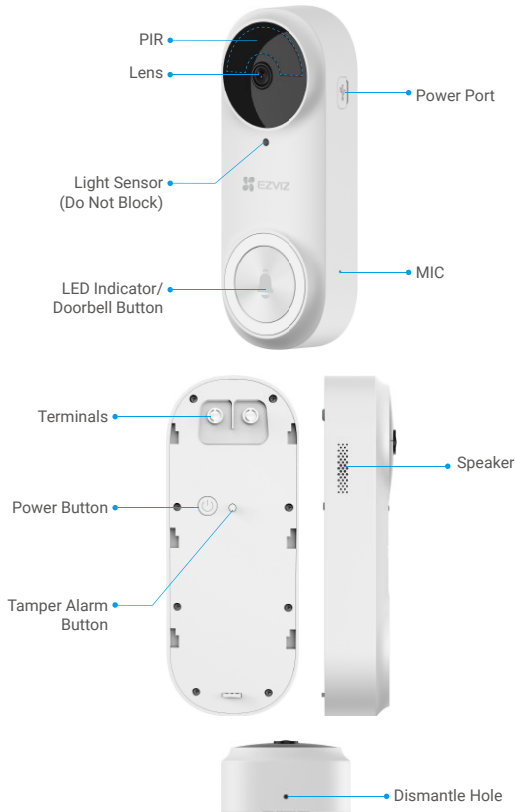



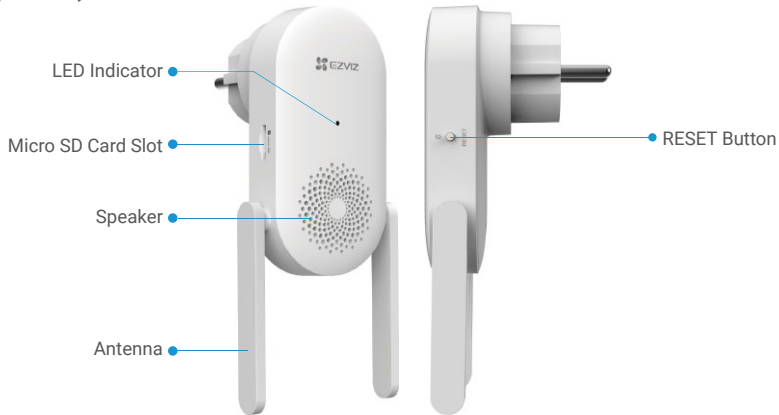

Name	Description
LED Indicator	<ul style="list-style-type: none"> <li>• <span style="color: red;">●</span> <span style="color: red;">●</span> Slow-Flashing Red: Charging.</li> </ul>
	<ul style="list-style-type: none"> <li>• <span style="color: red;">▬</span> <span style="color: gray;">●</span> Solid Red for 3 seconds and off:                             <ul style="list-style-type: none"> <li>• Person detected and less than 20% of battery</li> <li>• Doorbell button pressed and less than 20% of battery.</li> </ul> </li> </ul>
	<ul style="list-style-type: none"> <li>• <span style="color: blue;">▬</span> <span style="color: gray;">●</span> Solid Blue for 3 seconds and off:                             <ul style="list-style-type: none"> <li>• Person detected and more than 20% of battery</li> <li>• Doorbell button pressed and more than 20% of battery.</li> </ul> </li> </ul>
	<ul style="list-style-type: none"> <li>• <span style="color: blue;">▬</span> <span style="color: blue;">▬</span> Solid Blue: Fully charged and still connected to the power outlet.</li> </ul>
Power Button	<ul style="list-style-type: none"> <li>• Short press for 2 seconds: Turn on the doorbell.</li> <li>• Long press for 5 seconds: Turn off the doorbell.</li> </ul>

## 4. Basics (Chime)



**i** The appearance of chime is subject to the actual one you have bought, this manual we take the Europe chime as an example.

Name	Description
Antenna	Enhances the transmission of wireless network signal between the Chime and other wireless network terminals.
Micro SD Card (sold separately)	It is recommended to install a micro SD card, which should be purchased separately: <ul style="list-style-type: none"> <li>• Initialize the card in the EZVIZ app before using it.</li> <li>• Recommended compatibility: Class 10, maximum space 256GB.</li> </ul>
LED Indicator	 Solid Red: Chime is starting up.
	 Slow-Flashing Red: Wi-Fi connection has failed.
	 Fast-Flashing Red: Failed to link to the doorbell./ Micro SD card exception.
	 Solid Blue: Chime is functioning properly.
	 Fast-Flashing Blue: Chime is ready for Wi-Fi connection.
RESET Button	<ul style="list-style-type: none"> <li>• RESET the Chime: Hold for 5 seconds to restart and all parameters are RESET to default.</li> <li>• One-click mute: Press the Button once to mute the Chime for 30 seconds.</li> </ul>
Power Input	100 to 240 VAC, 50/60Hz

## Setup

### Follow the steps to set your doorbell kit:

1. Get the EZVIZ app, and log in to your EZVIZ app account.
2. Choose an installation location.
3. Power on your chime in the kit.
4. Add the chime to your EZVIZ user account.
5. Power on your Doorbell in the kit.
6. Check whether the linkage between the doorbell and chime is successfully.

### 1. Get the EZVIZ App

1. Connect your mobile phone to Wi-Fi (suggested).
2. Download and install the EZVIZ app by searching "EZVIZ" in the App Store or Google Play™.
3. Launch the app and register an EZVIZ user account.

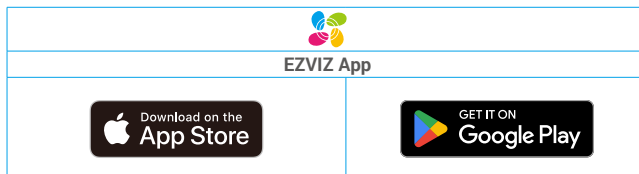

 If you have already used the app, please make sure that it is the latest version. To find out if an update is available, go to the app store and search for EZVIZ.

## 2. Choose an Installation Location

Choose a location with a good wireless signal to the Chime. Please keep the following tips in mind:

- Find a location between your Wi-Fi router and your doorbell (within 4 meters from the doorbell installation location).



## 3. Plug in Chime

1. Plug the Chime into a power outlet. When the LED indicator is fast-flashing blue, it is ready for Wi-Fi connection.



## 4. Add the Chime to EZVIZ

1. Log in to your EZVIZ account.
2. On the Home screen, tap "+" on the upper-right corner to go to the Scan QR Code interface.
3. Scan the QR Code on the cover of the quick start guide or on the body of the Chime.



4. Follow the EZVIZ app wizard to finish Wi-Fi configuration.

## 5. Power On the Doorbell

1. Short press the power button for 2 seconds to turn on the doorbell.

The doorbell LED indicator goes out after turning blue for 3 seconds, indicating that the doorbell is turned on.

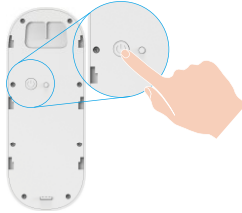

If the doorbell is out of battery, connect it to power outlet with the power adapter (5V 2A, purchase separately) for charging. It is recommended to fully charge the doorbell before you use it for the first time.



- 1 • When charging, the doorbell will automatically turn on.
- If you use a 5V 2A adapter to charge the doorbell, it will take about 4.5 hours to fully charge.
- If the doorbell is installed outdoors, please use waterproof power cable to charge.
- When charging the doorbell, make sure the lens faces upward to avoid fraying the lens.

2. When the doorbell is turned on, it will connect to the network by automatically linking to the chime.



Make sure your Chime is placed as close to the Doorbell as possible for optimal performance.  
Make sure your Chime is placed as close to the router as possible for optimal performance.

## 6. Check the Linkage

Press the doorbell button to check. If the chime rings indicating that the connection is successful.



- **When the doorbell is linked**, the chime will give out reminders that there are visitors or someone comes up if the doorbell is triggered.
- **If the doorbell failed to connect to the network**, please adjust the position of the chime. It is recommended to put the chime and doorbell within 4 meters.
- **If the chime failed to connect to the network**, the doorbell beeps twice and the chime LED indicator fast-flashing blue. Please check the network and if the Wi-Fi password is correct.
- **If the chime is connected to network but failed to registered to the platform**, the doorbell beeps twice and the chime LED indicator solid blue. Please check the network and use your cell phone for help.

# Installation

## 1. Micro SD Card Installation (Optional)

**i** If you bought the chime with a doorbell, it is recommended to install a micro SD card.

1. Insert the micro SD card (sold separately) into the card slot on the chime as shown in the figure below.



**i** After installing the micro SD card, you should initialize the card in the EZVIZ app before using it.

2. In the EZVIZ app, tap the Storage Status in the Device Settings interface to check the SD card status.

3. If the memory card status displays as Uninitialized, tap to initialize it. The status will then change to Normal and it can store videos.

**i** The status will then change to Normal and then videos can be stored.

## 2. Doorbell Installation Height

### 1. Installation height

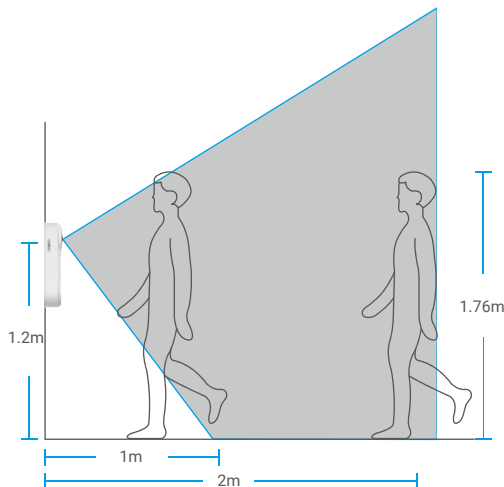

- Recommended installation height: 1.2m-1.5m.
- The following situations are not recommended for installation. Otherwise the network connection may be affected:
  1. Iron doors;
  2. Corners of load-bearing walls.
- Please make sure you have finished Wi-fi configuration of the chime and its LED indicator is solid blue before installation.



## 3. Select the mounting plate.

Use only the mounting plate, or use with one of the inclined mounting plates as a supplementary mounting bracket if you wish



to see more on a specific side.



1 Adjust the view coverage with different mounting plate.

### How to install the inclined mounting plate

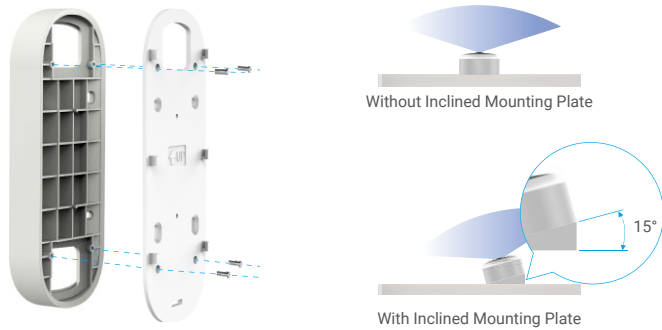

Fig.1 Inclined Mounting Plate 1

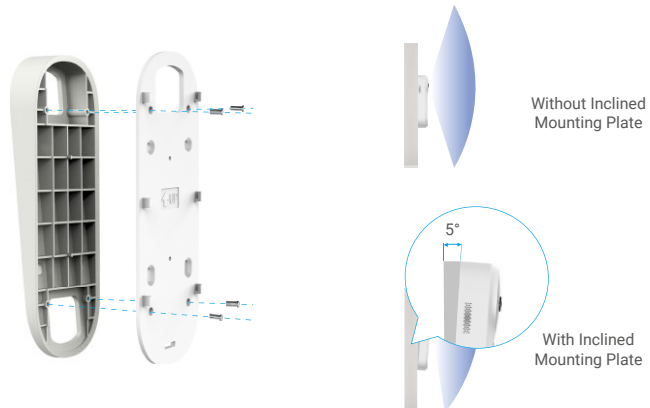
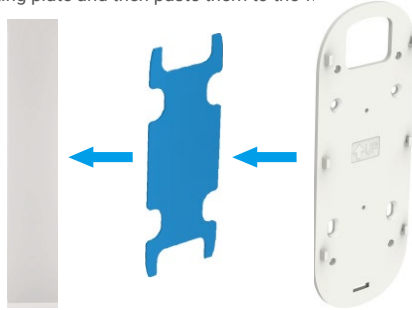

Fig.2 Inclined Mounting Plate 2

## 4. Install the mounting plate.

### Option A (for smooth wall)

1. Stick the plate foam on the mounting plate and then paste them to the wall.



- i** You can adjust the view coverage with inclined mounting plate.

### Option B (for uneven wall)

1. Place the drill template onto the surface you have chosen to mount the doorbell, and drill four screw holes.

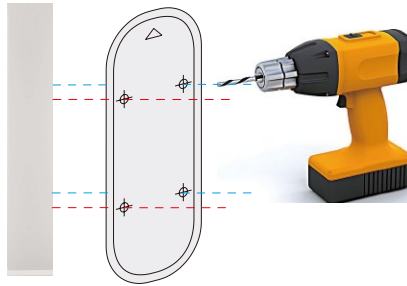

- i** It is recommended to use a drill with diameter of 6mm.

2. (Optional) Insert four anchors to the holes. There is no need to use anchor if you were installing on wooden doorframe.

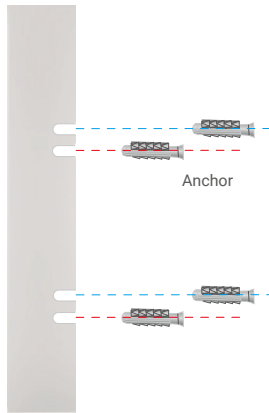

3. Stick the foam sticker on the mounting plate and then use screws (KA3x16) to fix the mounting plate to the wall as shown in the figure follow. (Please fix the upper two screws first.)

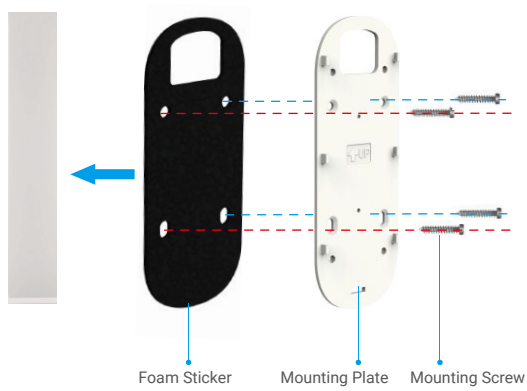

**i** You can adjust the view coverage with included mounting plate.

## 5. Install the doorbell.

Install the doorbell to the mounting plate.

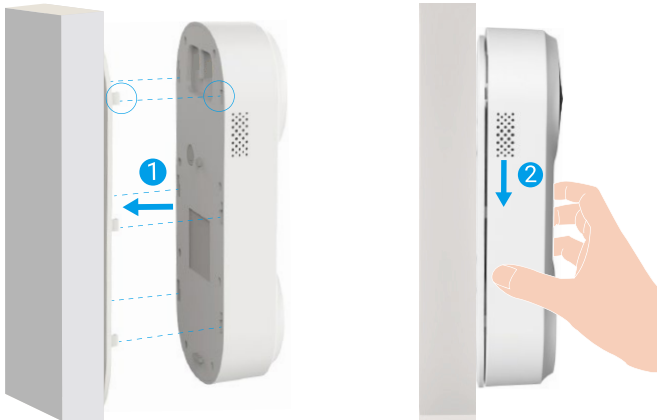

# Maintenance

## 1. Disassemble

1. Turn off the **Tamper Notification** on the EZVIZ app.
2. Use the pin provided to press and hold the hole on the bottom of the doorbell, meanwhile push the doorbell upwards and then take it off.

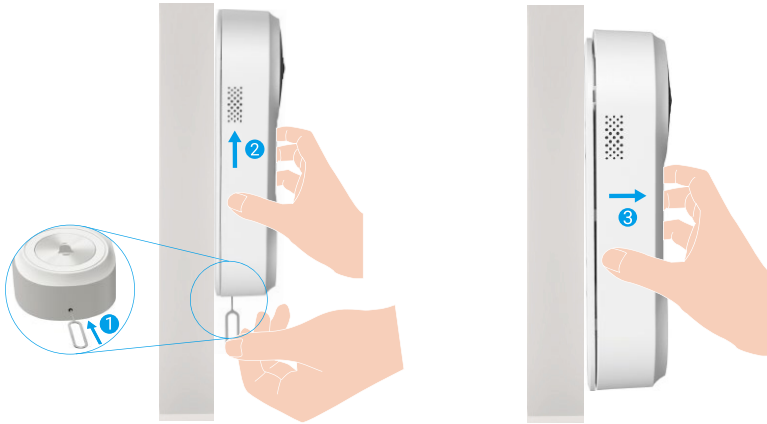

## 2. Charge

Connect the doorbell to power outlet via power adapter.



- When charging, the doorbell will automatically turn on.
- If you use a 5V 2A adapter to charge the doorbell, it will take about 4.5 hours to fully charge.
- If the doorbell is installed outdoors, please use waterproof power cable to charge.
- When charging the doorbell, make sure the lens faces upward to avoid fraying the lens.

## Appendix (Optional)

### Replace the existing doorbell with the EZVIZ doorbell

If you have an existing doorbell system or have installed a mechanical or electronic chime, you can replace the existing doorbell with the EZVIZ doorbell.

- Please ring the existing doorbell first to make sure it's working.
- Determine the mounting position of the doorbell, and check if you can reuse the existing holes on the wall.

- We recommend installing a new transformer to bring the output **16 to 24** volts.
  - Please refer to Quick Start Guide of your chime or transformer for the chime or transformer installing details.

## 1. Shut off the electricity at the breaker

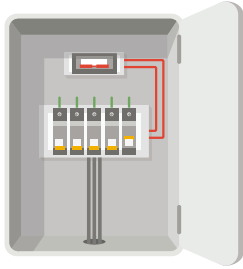

- 1 Note: Always be careful when handling electricity wiring. If you're not comfortable to do it yourself, do consult a qualified electrician.

## 2. Connect the wires

1. Remove the old doorbell, take out the existing wires and pass it through the mounting plate.
2. Connect the existing doorbell wires to the terminals at the back of the EZVIZ doorbell, then tighten the terminal screws.

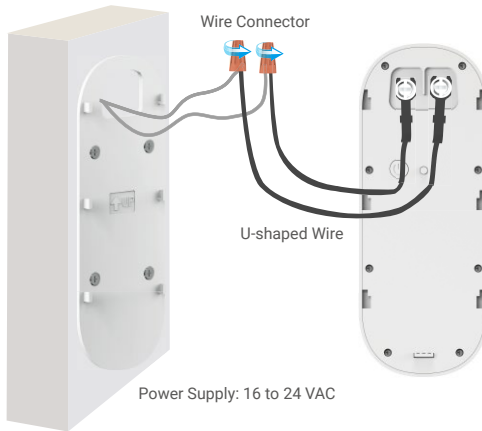

## 3. Install the Doorbell

Install the doorbell to the mounting plate.



## 4. Restore power at the breaker.

# View Your Device

**i** The app interface may be different due to version update, and the interface of the app you installed on your phone shall prevail.

## 1. Live View

When you launch the EZVIZ app, the device page displays as shown below. You can view and listen to a live feed, take snapshots, record videos, and choose video definition as needed.

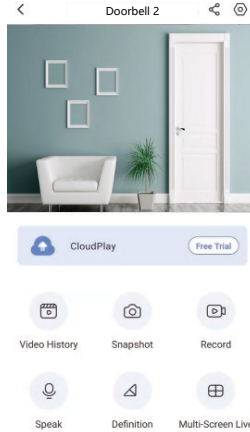

**i** Swipe left and right across the screen to see more icons.

Icon	Description
	Share. Share your device with anyone you want.
	Settings. View or change the device settings.
	Video History. View Recordings.
	Snapshot. Take a snapshot.
	Record. Manually start/stop recording.
	Multi-screen Live. Tap to select live view window layout.
	Speak. Start using talk and listen.
	Definition. Select video resolution from Ultra HD, Hi-Def or Standard.
<b>i</b>	Please refer to the actual interface for specific information.

# Settings

## 1. Doorbell

In the settings page, you can set the parameters of the doorbell.

Parameter	Description
Name	View or tap to customize the name of your device here.
Working Mode	You can select one kind of device working modes here.
Intelligent Detection	You can select between different detection types for your device.
Notification	You can manage the device message and EZVIZ App notification.
Audio Settings	You can set relevant audio parameters for your device.
Image Settings	You can set relevant image parameters for your device.
Light Settings	When disabled, the doorbell indicator will be off.  Exceptions: The doorbell indicator will still be on, when the doorbell is charging or the doorbell is exception.
Speaker Settings	You can set relevant parameters of your speaker.
Battery	You can see the battery remaining capacity here.
Security Settings	You can encrypt your videos with encryption password and customize the privacy area.
Network Settings	You can see the connection status.
Device Information	You can see the device information here.
Share Device	You can share the device to you family member or guest.

## 2. Chime

In the settings page, you can set the parameters of the Chime.

Parameter	Description
Name	View or tap to customize the name of your device here.
Audio Settings	You can set volume and enable the doorbell ring DND mode.
Light Settings	When disabled, the device indicator will be off.
Record List	You can see the device storage status of the memory card.
Network Settings	You can see the Wi-Fi name and the connection status.  If you want to change your device's Wi-Fi, please hold the [RESET] button for 5 seconds or so to RESET the device.
Device Information	You can see the device information here.
Delete Device	Tap to delete the device from EZVIZ App.

# EZVIZ Connect

## 1. Use Amazon Alexa

These instructions will enable you to control your EZVIZ devices with Amazon Alexa. If you run into any difficulties during the process, please refer to **Troubleshooting**.

### Before you start, make sure that:

1. EZVIZ devices are connected to the EZVIZ app.
2. In the EZVIZ app, turn off the "Video Encryption" and turn on the "Audio" in the Device Settings page.
3. You have an Alexa-enabled device (i.e Echo Spot, Echo-Show, All-new Echo-Show, Fire TV (all generations), Fire TV stick (second generation only), or Fire TV Edition smart TVs).
4. The Amazon Alexa app is already installed on your smart device, and you have created an account.

### To Control EZVIZ devices with Amazon Alexa:

1. Open the Alexa app and select "Skills and Games" from the menu.
2. On the Skills and Games screen, search for "EZVIZ", and you will find "EZVIZ" skills.
3. Select your EZVIZ device's skill, then tap ENABLE TO USE.
4. Enter your EZVIZ username and password, and tap Sign in.
5. Tap the Authorize button to authorize Alexa to access your EZVIZ account, so that Alexa can control your EZVIZ devices.
6. You will see "EZVIZ has been successfully linked", then tap DISCOVER DEVICES to allow Alexa to discover all your EZVIZ devices.
7. Go back to Alexa app menu and select "Devices", and under devices you will see all your EZVIZ devices.

### Voice Command

Discover a new smart device via the "Smart Home" menu in the Alexa app or the Alexa Voice Control function.

Once the device is found, you can control it with your voice. Speak simple commands to Alexa.

- Your device's name for example: "show xxxx camera," can be modified in the EZVIZ app. Every time you change the name of the device, you will need to discover the device again to update the name.

### Troubleshooting

#### What do I do if Alexa fails to discover my device?

Check if there are any Internet connecting problems.

Try to reboot the smart device and re-discover the device on Alexa.

#### Why does the device's status show "Offline" on Alexa?

Your wireless connection might have been disconnected. Reboot the smart device and re-discover on Alexa.

Internet access on your router could be unavailable. Check if your router is connected to the Internet and try again.

- For details about countries that support the using of Amazon Alexa, see its official website.



## 2. Use Google Assistant

With the Google Assistant, you can activate your EZVIZ device and watch live by speaking Google Assistant voice commands.

### The following devices and apps are required:

1. A functional EZVIZ app.
2. In the EZVIZ app, turn off the "Video Encryption" and turn on the "Audio" in the Device Settings page.
3. A TV with functional Chromecast connecting to it.
4. The Google Assistant app on your phone.

### To get started, follow the steps below:

1. Set up the EZVIZ device and make sure it works properly on the app.
2. Download the Google Home app from the App Store or Google Play Store™ and log into your Google account.
3. On the Myhome screen, tap "+" on the upper-left corner, and select "Set up device" from the menu list to go to the Set up interface.
4. Tap **Works with Google**, and search for "EZVIZ", where you will find "EZVIZ" skills.
5. Enter your EZVIZ username and password, and tap **Sign in**.
6. Tap the **Authorize** button to authorize Google to access your EZVIZ account, so that Google can control your EZVIZ devices.
7. Tap **Return to app**.
8. Follow the above steps to complete the authorization. When synchronization is completed, EZVIZ service will be listed under your list of services. To see a list of compatible devices under your EZVIZ account, tap on the EZVIZ service icon.
9. Now try some commands. Use the name of the camera that you created when you set up the system.

Users can manage devices as a single entity or in a group. Adding devices to a room allows users to control a group of devices at the same time using one command.

See the link for more information:

<https://support.google.com/googlehome/answer/7029485?co=GENIE.Platform%3DAndroid&hl=en>

 For additional information about the device, please refer to [www.ezviz.com/eu](http://www.ezviz.com/eu).

## Initiatives on the Use of Video Products

Thank you for choosing EZVIZ products.

Technology affects every aspect of our life. As a high-tech company, we are increasingly aware of the role technology plays in improving business efficiency and quality of life, but at the same time, the potential harm of its improper usage. For example, video products are capable of recording real, complete and clear images. This provides a high value in retrospect and preserving real-time facts. However, it may also result in the infringement of a third party's legitimate rights and interests if improper distribution, use and/or processing of video data takes place. With the philosophy of "Technology for the Good", EZVIZ requests that every end user of video technology and video products shall comply with all the applicable laws and regulations, as well as ethical customs, aiming to jointly create a better community.

Please read the following initiatives carefully:

1. Everyone has a reasonable expectation of privacy, and the installation of video products should not be in conflict with this reasonable expectation. Therefore, a warning notice shall be given in a reasonable and effective manner and clarify the monitoring range, when installing video products in public areas. For non-public areas, a third party's rights and interests shall be evaluated when installing video products, including but not limited to, installing video products only after obtaining the consent of the stakeholders, and not installing highly-invisible video products.

2. The purpose of video products is to record real activities within a specific time and space and under specific conditions. Therefore, every user shall first reasonably define his/her own rights in such specific scope, in order to avoid infringing on a third party's portraits, privacy or other legitimate rights.

3. During the use of video products, video image data derived from real scenes will continue to be generated, including a large amount of biological data (such as facial images), and the data could be further applied or reprocessed. Video products themselves could not distinguish good from bad regarding how to use the data based solely on the images captured by the video products. The result of data usage depends on the method and purpose of use of the data controllers. Therefore, data controllers shall not only comply with all the applicable laws and regulations and other normative requirements, but also respect international norms, social morality, good morals, common practices and other non-mandatory requirements, and respect individual privacy, portrait and other rights and interests.

4. The rights, values and other demands of various stakeholders should always be considered when processing video data that is continuously generated by video products. In this regard, product security and data security are extremely crucial. Therefore, every end user and data controller, shall undertake all reasonable and necessary measures to ensure data security and avoid data leakage, improper disclosure and improper use, including but not limited to, setting up access control, selecting a suitable network environment (the Internet or Intranet) where video products are connected, establishing and constantly optimizing network security.

5. Video products have made great contributions to the improvement of social security around the world, and we believe that these products will also play an active role in more aspects of social life. Any abuse of video products in violation of human rights or leading to criminal activities are contrary to the original intent of technological innovation and product development. Therefore, each user shall establish an evaluation and tracking mechanism of their product application to ensure that every product is used in a proper and reasonable manner and with good faith.

## 1. Rechargeable Lithium ion Battery

1. The battery type of the device: Portable battery.
2. The battery of this device is non-removable, which is risky to remove.

Component Parts	Hazardous Ingredients ( Chemical Name)	CAS No.	Concentration Ranges	Chemical Formula
Anode	Lithium Manganese Nickel and Cobalt Oxide	346417-97-8	36.3%	$\text{LiNi}_x\text{Co}_y\text{Mn}_{1-x-y}\text{O}_2$
	Polyvinylidene Fluoride(PVDF)	24937-79-9	0.48%	$(\text{C}_2\text{H}_2\text{F}_2)_n$
Cathode	Graphite	7782-42-5	19.38%	C
	Styrene-Butadiene Rubber(SBR)	9003-55-8	0.27%	$\text{C}_{12}\text{H}_{14}$
	sodium carboxymethyl cellulose	9004-32-4	0.22%	$\text{C}_6\text{H}_7\text{O}_2(\text{OH})_2\text{OCH}_2\text{COONa}_n$
	Nickel	7440-02-0	0.33%	Ni
AL-foil	Aluminium	7429-90-5	2.68%	Al
Cu-foil	Copper	7440-50-8	6.66%	Cu
Electrolyte	Lithium Hexafluorophosphate	21324-40-3	1.79%	$\text{LiPF}_6$
	Ethylene Carbonate(EC)	96-49-1	2.8%	$\text{C}_3\text{H}_4\text{O}_3$
Separator	Polyethylene(PE)	9002-88-4	2%	$(\text{C}_2\text{H}_4)_n$
PET film	Polyethylene terephthalate(PET)	25038-59-9	0.9%	$\text{C}_{10}\text{H}_{12}\text{O}_6$
cell case	Fe	7439-89-6	17%	Fe
others	others	/	9.19%	/

## 2. INFORMATION FOR PRIVATE HOUSEHOLDS

1. Separate collection of waste equipment: Electrical and electronic equipment that has become waste is referred to as waste equipment. Owners of waste equipment must dispose of it separately from unsorted municipal waste. In particular, waste equipment does not belong in household waste, but in special collection and return systems.

2. Batteries and rechargeable batteries as well as lamps: Owners of waste equipment shall, as a rule, separate waste batteries and rechargeable batteries that are not enclosed in the waste equipment, which can be removed from the waste equipment without being destroyed, from the waste equipment before handing them in at a collection point. This does not apply if waste equipment is prepared for reuse with the participation of a public waste management authority.

3. Options for returning waste equipment: Owners of waste equipment from private households can return it free of charge to the collection points of the public waste management authorities or to the take-back points set up by manufacturers or distributors within the meaning of the Electrical and Electronics Equipment Law. Stores with a sales area of at least 400 m<sup>2</sup> for electrical and electronic equipment and those grocery stores with a total sales area of at least 800 m<sup>2</sup> that offer electrical and electronic equipment several times a year or on a permanent basis and make it available in the market are required to take it back. This also applies in the case of distribution using means of distance communication, if the storage and shipping areas for electrical and electronic equipment are at least 400 m<sup>2</sup> or the total storage and shipping areas are at least 800 m<sup>2</sup>. Distributors shall, in principle, ensure take-back by providing suitable return facilities at a reasonable distance from the respective end user. The possibility of returning waste equipment free of charge exists for distributors who are obliged to take it back, among other things, if a new similar device that essentially fulfills the same functions is delivered to an end user.

4. Privacy Notice: Waste equipment often contains sensitive personal data. This applies in particular to devices of information and telecommunications technology such as computers and smartphones. In your own interest, please note that each end user is responsible for deleting the data on the waste equipment to be disposed of.

5. Meaning of the symbol “crossed-out wheelie bin”: The symbol of a crossed-out wheelie bin regularly depicted on electrical and electronic equipment indicates that the respective device is to be collected separately from unsorted municipal waste at the end of its service life.